

## Product Datasheet

# 2-in-1 Kombiantenne

## CELLULAR/LTE and GNSS Screw Mount

### Key Features

#### Cable 1: CELLULAR / LTE

- 698-960 MHz
- 1710-2170 MHz
- 2500-2700 MHz

#### Cable 2: GPS/GLONASS/QZSS/Galileo

- 1575-1606 MHz

Screw Mount

Anti-Rotation Mechanism

Ground Plane Independent

Customizable Cable and Connector

Dimensions 80 × 74 × 25.6 mm

Certificates: IP67, IP69



## 1. Antenna and electrical specifications

**Cable 1**

Parameters	CELLULAR / LTE Antenna		
<b>Standards</b>	2G,3G and 4G		
<b>Band (MHz)</b>	700/850/900	1700/1800/1900/2100	2600
<b>Frequency (MHz)</b>	698-960	1710-2170	2500-2700
<b>Return Loss (dB)</b>	~-9.3	~-6.8	~-19.9
<b>VSWR</b>	~2.1:1	~2.7:1	~1.3:1
<b>Efficiency (%)</b>	~45.9	~50.3	~64.1
<b>Peak Gain (dBi)</b>	~-2.7	~-5.1	~-5.3
<b>Average Gain (dB)</b>	~-3.8	~-3.2	~-1.9
<b>Impedance (Ohm)</b>	50		
<b>Polarisation</b>	Linear		
<b>Radiation Pattern</b>	Omni-Directional		
<b>Max. Input Power (W)</b>	25		
<b>Connector Type</b>	SMA-Male Standard (Other Connectors Available)		
<b>Cable Length</b>	300 cm Standard (Any Cable Length Available)		
<b>Cable Type</b>	D302 Standard (Other Cables Available)		

**Cable 2**

Passive Parameters	GPS/GLONASS Antenna	
<b>Standards</b>	GPS/QZSS/Galileo	GLONASS
<b>Bands (MHz)</b>	1575	1602
<b>Frequency (MHz)</b>	1575.42	1598-1606
<b>Return Loss (dB)</b>	<=-20	<=-15
<b>VSWR</b>	<=1.2:1dB	<=1.4:1dB
<b>Efficiency (%)</b>	~65	~68
<b>Peak Gain (dBiC)</b>	~3.6	~3.9
<b>Average Gain (dB)</b>	~1.8	~1.6
<b>Impedance (Ohm)</b>	50	
<b>Polarization</b>	RHCP	
<b>Radiation Pattern</b>	Hemispherical	
<b>Connector Type</b>	SMA-Male Standard (Other Connectors Available)	
<b>Cable Length (m)</b>	300 cm Standard (Any Cable Length Available)	
<b>Cable Type</b>	LL100	

**Antenna Measurement Conditions:**

Mounted on Metal Plate of 30 x 30 cm  
200 cm of Cable D302  
Measured in Certified CTIA 3D Anechoic Chamber

## 2. Mechanical and environmental specifications

<b>Specifications</b>	
<b>Mounting Type</b>	Screw Mount
<b>Dimensions (mm)</b>	80 × 74 × 25.6
<b>Max. Tighten Torque (Nm)</b>	5 Nm
<b>Radome Type</b>	ASA UV Stable
<b>Radome Color</b>	Black, White
<b>Operating Temperature (C)</b>	-40 to +85
<b>Storage Temperature (C)</b>	-40 to +85
<b>Substance Compliance</b>	RoHS
<b>Certificates</b>	IP67, IP69

### 3. Antenna parameters

Table 1: CELLULAR/LTE

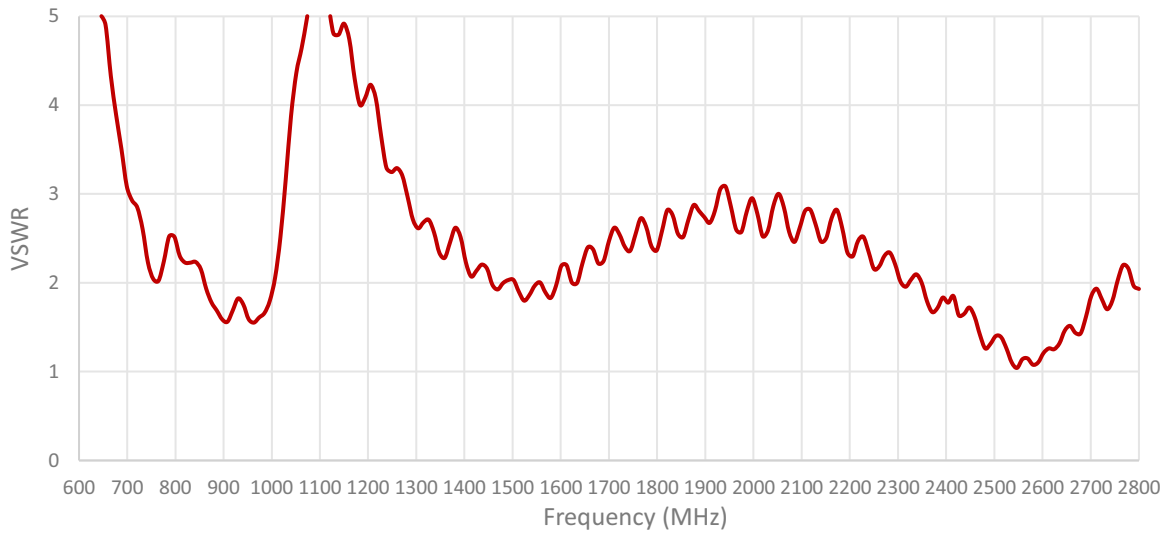
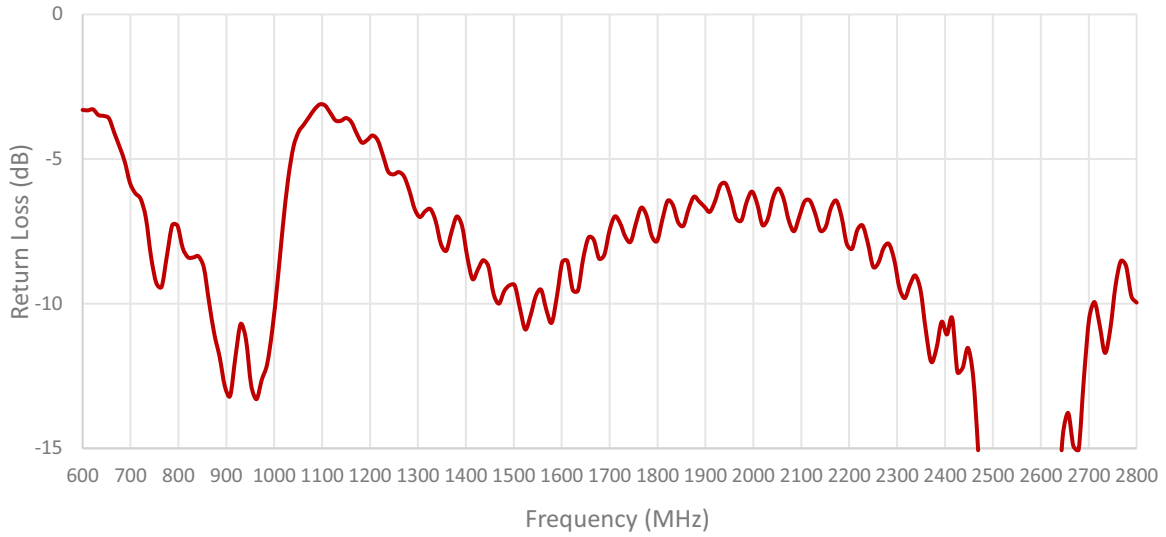

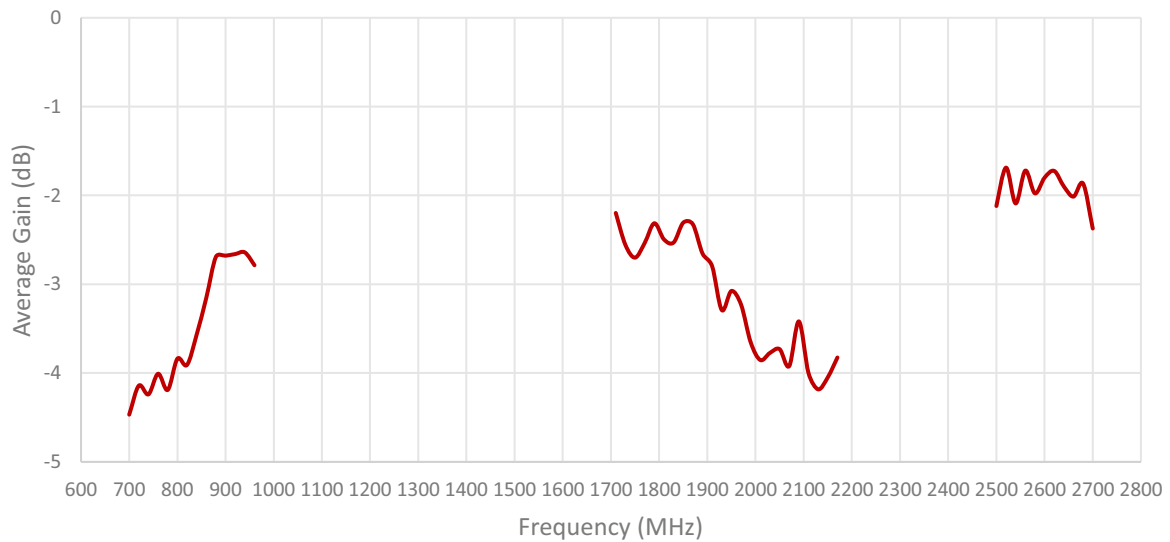
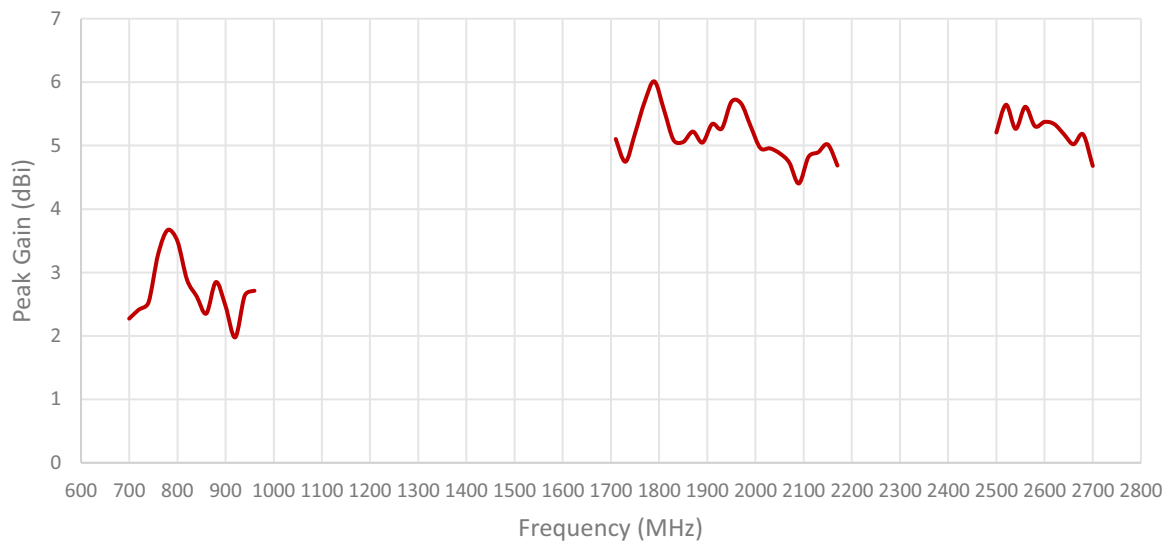
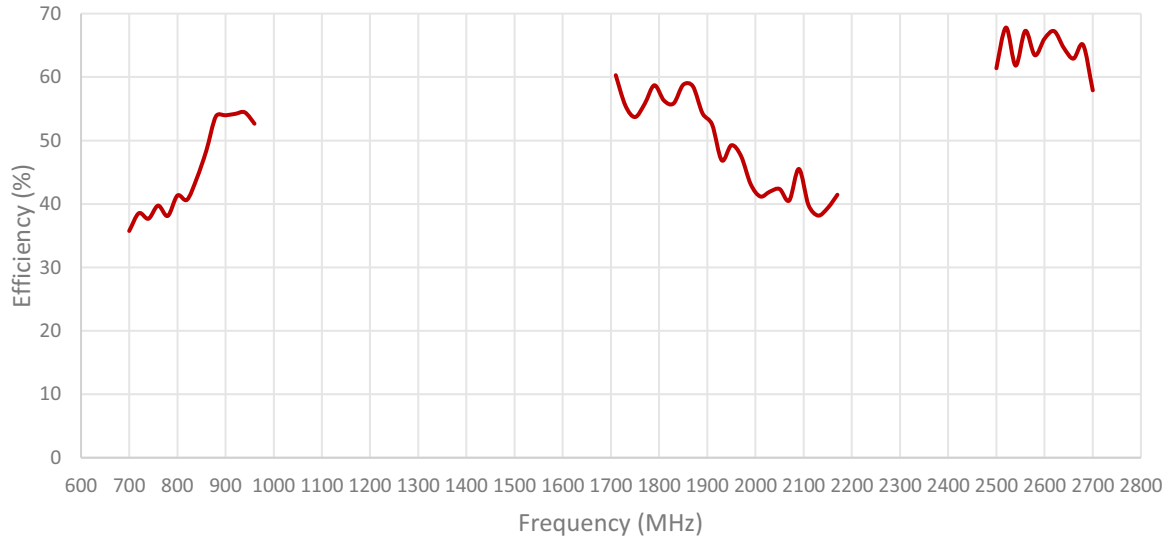

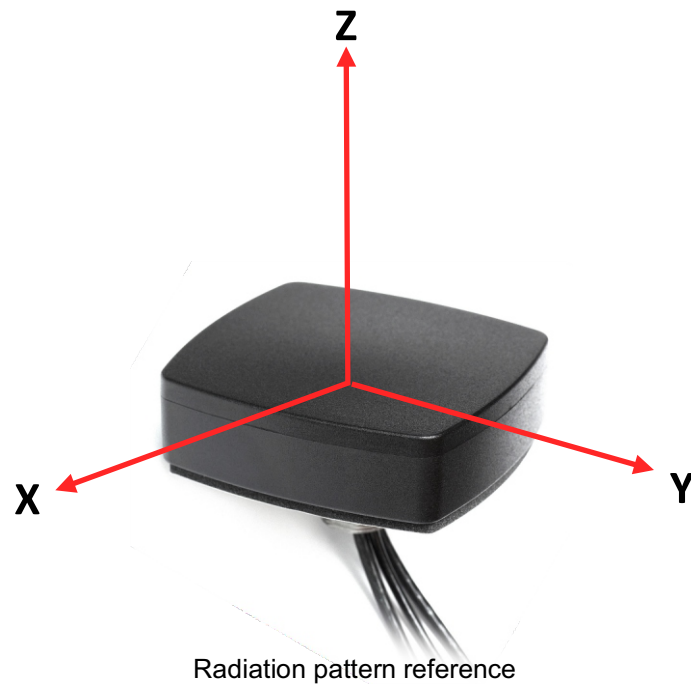

Cable 1: CELLULAR/LTE

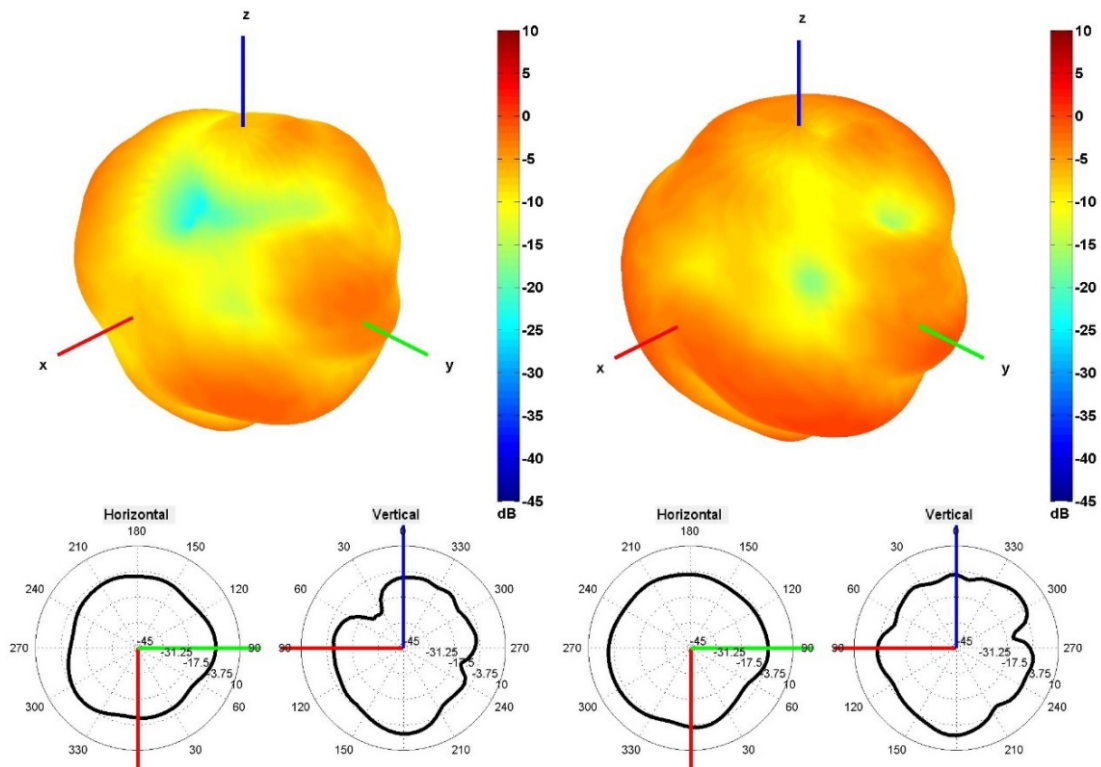

750 and 850 MHz Radiation pattern

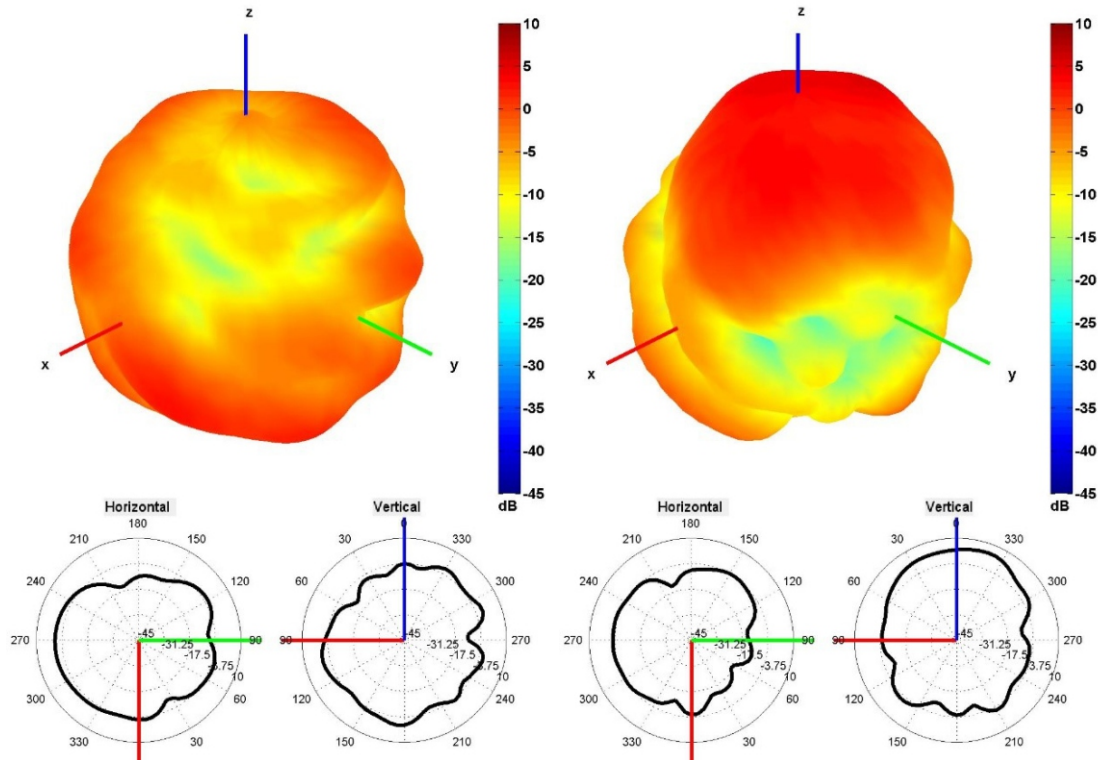

940 and 1750 MHz Radiation pattern

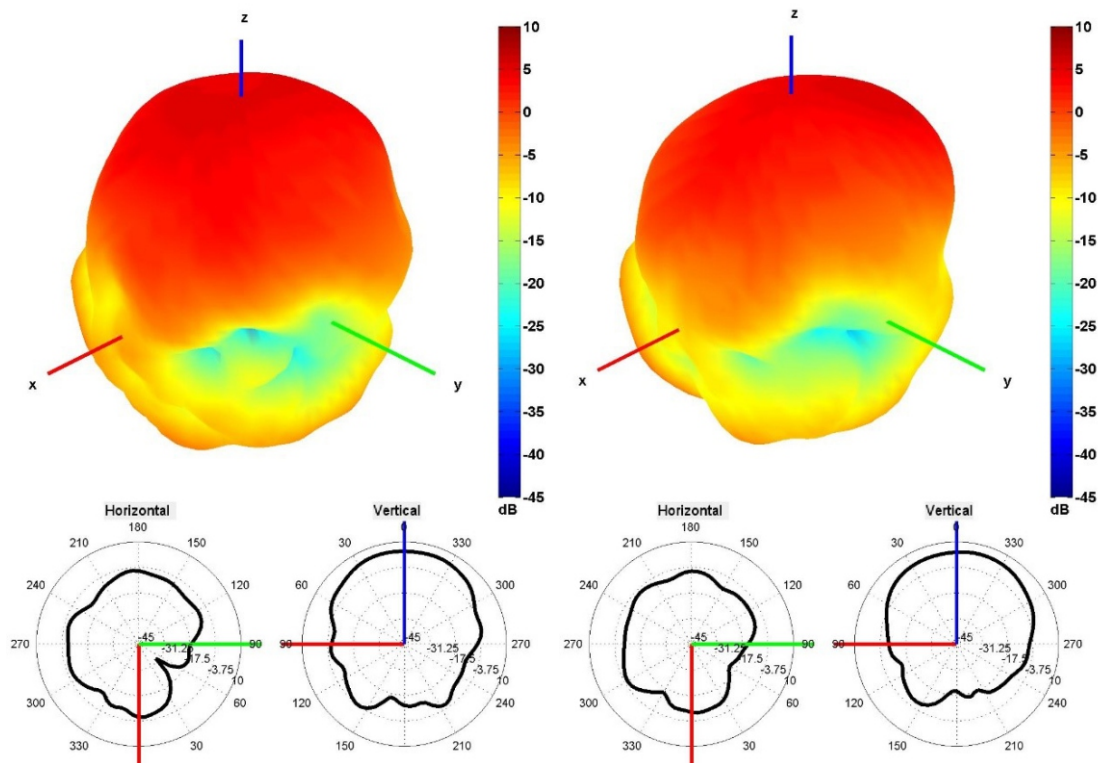

1850 and 1950 MHz Radiation pattern

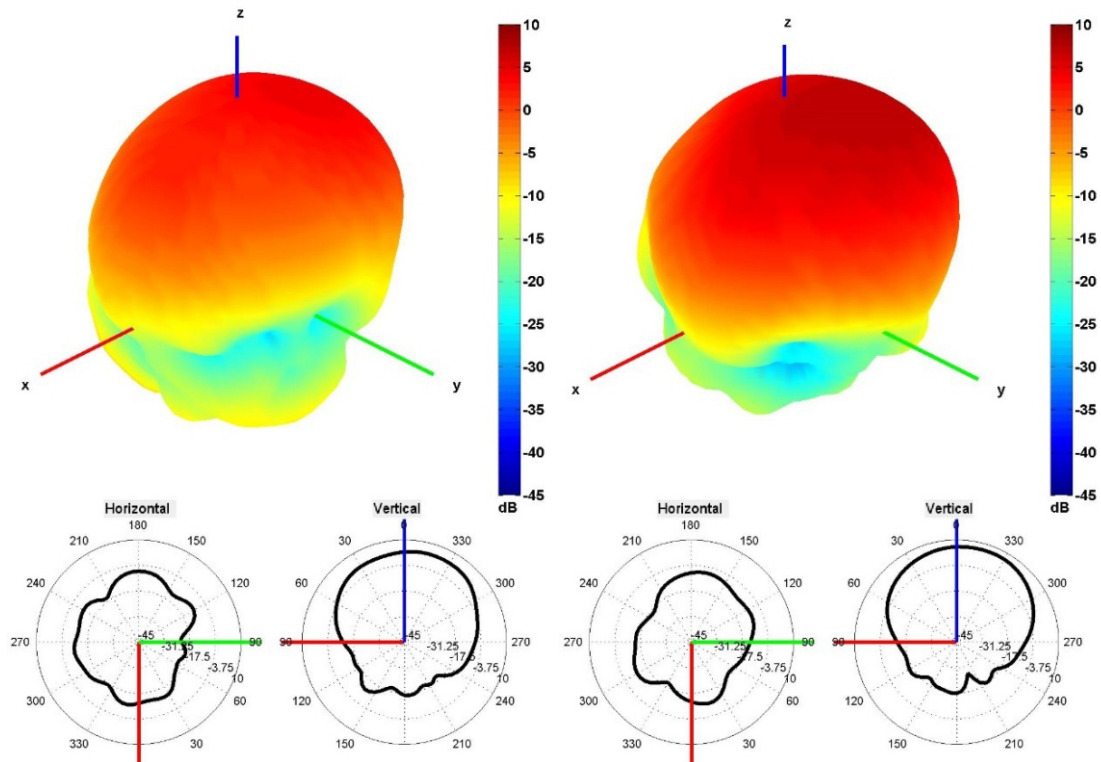

2100 and 2600 MHz Radiation pattern



## 4. Antenna drawings

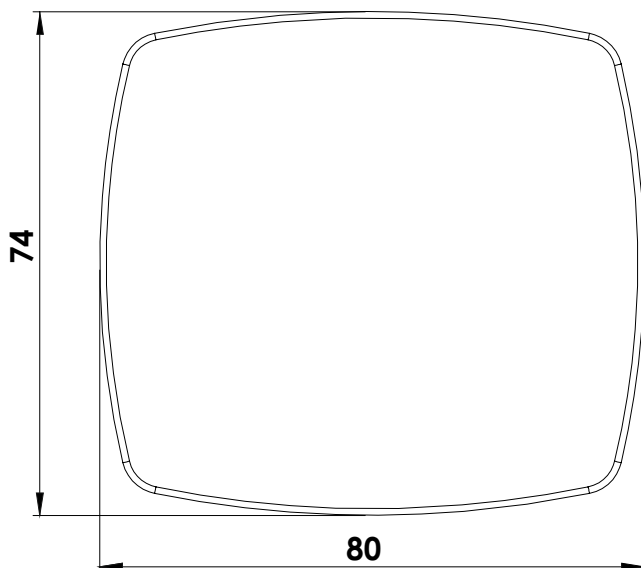
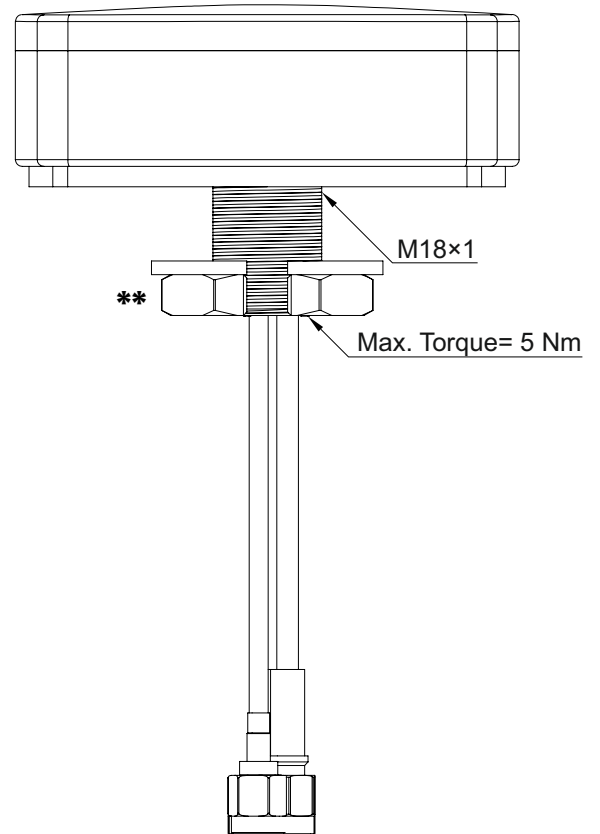
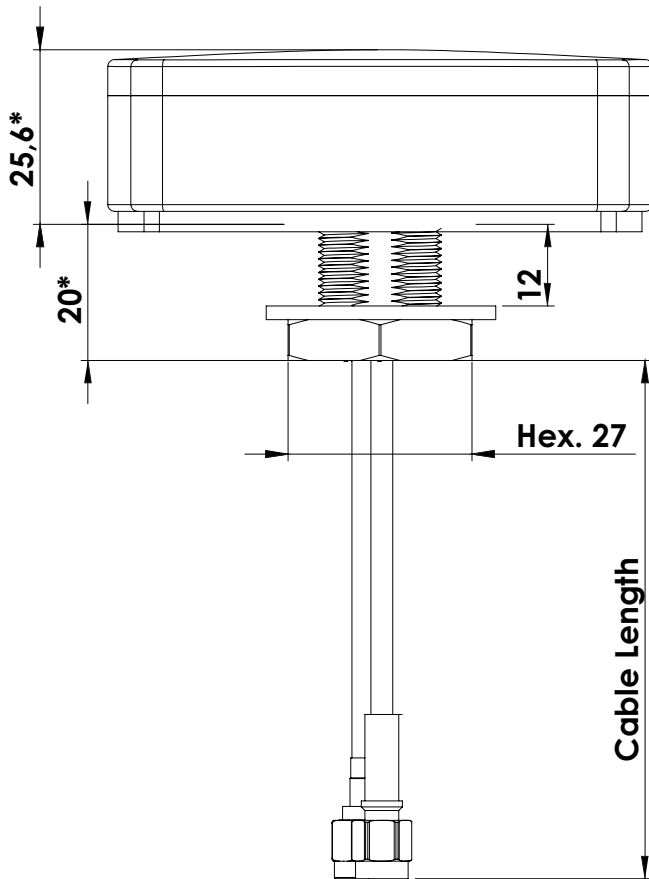

### Mounting hole

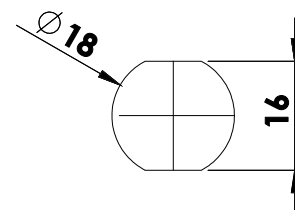

Max. mounting thickness 12mm  
Note: Dimensions are in millimeters  
\*Dimensions are after mounting  
\*\*Max. Torque= 5 Nm

## 5. Antenna Images

